

CENTRALNI PRIVOD VZDUCHU  
Zentralluftzufuhr  
Central air inlet  
 $\varnothing 120\text{mm}$

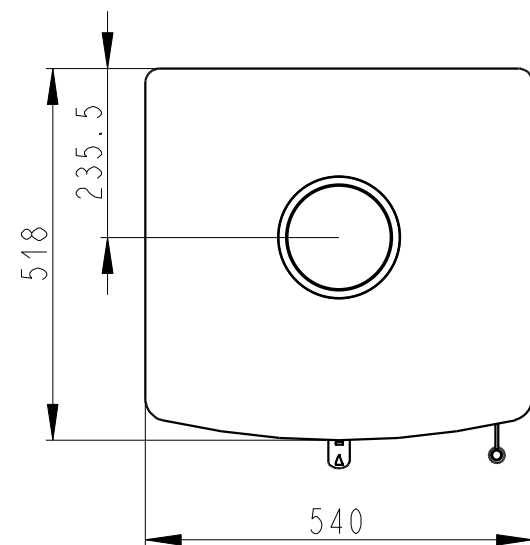

SEKUNDARNI VZDUCH  
Sekundärluft  
Secondary air  
A/UND/AND  
PRIMARNI VZDUCH  
Primärluft  
Primary air

